

APE explains why a vibration dampener is not used with APE Vibros



Some claim that a vibration dampener must be used with a vibro to suppress the vibration to the crane. This is not true when using APE Vibros on the job.

IMPERIAL
Crane
presenting **PILE DRIVING**
SOLUTIONS
piledrivingsolutions.com

THE VIBRATORY DAMPER

for the Pile Driving and Caisson Industry



- Easily and effectively reduces damage to cranes
- Minimal set up and maintenance
- Maximizes the safety of the crane work being done
- Extends the life expectancy of the crane
- Decreases extraction time
- Can be used on all model cranes

Visit us at the SC&RA Annual Conference April 30 - Orlando, FL - Booth #20

To purchase, contact Jay Mooncotch | jmooncotch@piledrivingsolutions.com | 708-774-5562



Lets look at the Vibration Dampener from a practical point of view and what its original design was intended to accomplish.



In the past, Chinese manufactured electric vibratory driver/ extractors use Rail Road Car Springs as their vibration suppressor. (As seen to the right)

These electric vibratory hammers did not have a built in Suppressor to keep the vibration out of the boom of the crane.

Their answer to boom shake was the “Spring Vibration Suppressor” and though it was rudimentary at best, it did it’s job and kept the vibration out of the boom of the crane.

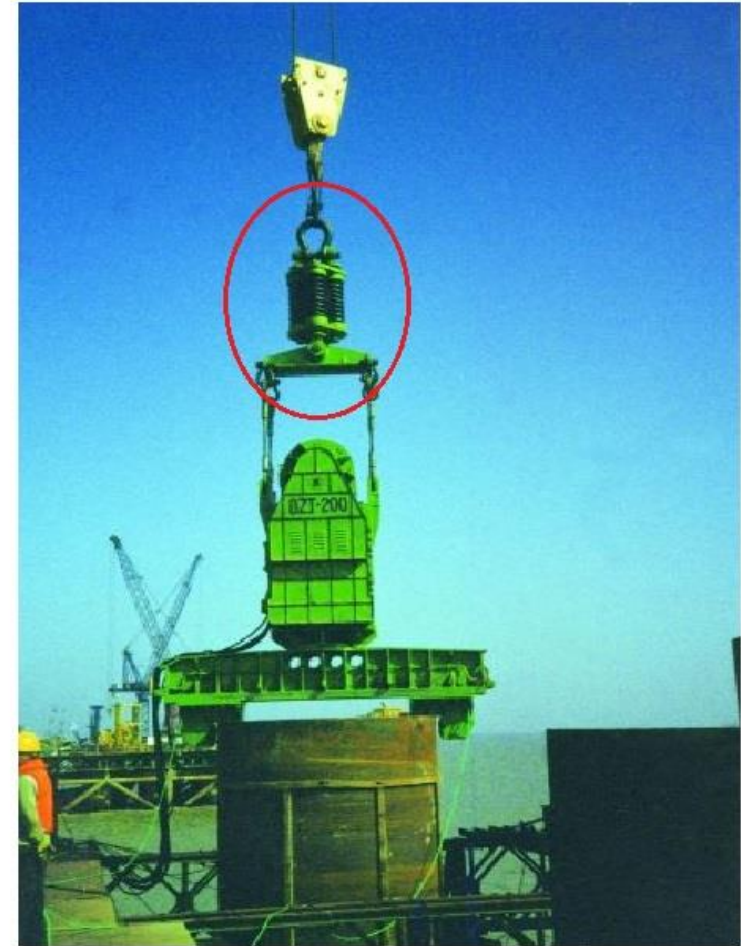

The Vibration Dampener was originally made for the Tunkers Vibratory hammer as seen below. The Tunkers vibratory hammer does NOT have a built in vibration suppressor system.



The reason for the Tunkers Vibration Dampener was the fact that the Tunkers Vibratory Hammers do NOT have a built in Vibration Suppressor System.

The APE Two-Stage Suppressor, below, is the highest state of the art suppressor system available on the market.

APE Two-Stage Suppressor



**Tunkers...
NO Suppressor**



Tunkers solution to NO Suppressor is the “Vibration Dampener”

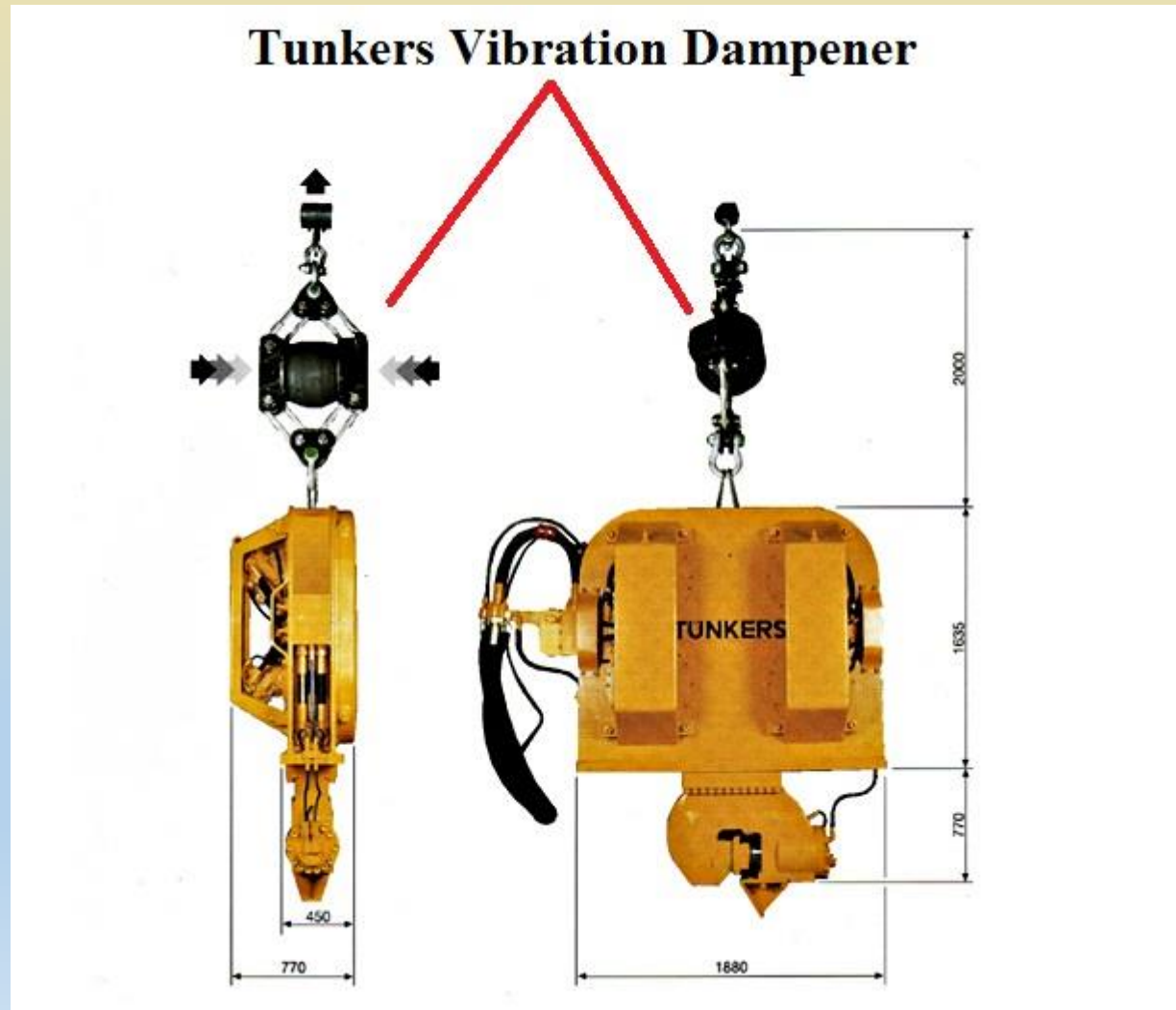

APE vs Tunkers

The APE vibratory hammer has a built in state of the art Two Stage Suppressor which eliminates boom shake.

Tunkers vibratory hammer is designed and built with no suppressor. Needing something to eliminate boom shake, Tunkers added the vibration dampener.

APE Two-Stage Suppressor



APE
Vibration Suppressor and
vibro bolted together as
ONE Complete Unit

VS

Tunkers...
NO Suppressor



+

Tunkers Vibration
Dampener



=

Two combined to
make one unit



For over 25 years APE has been driving and pulling piles with our vibratory driver/ extractors and our state of the art Two-Stage Suppressor System

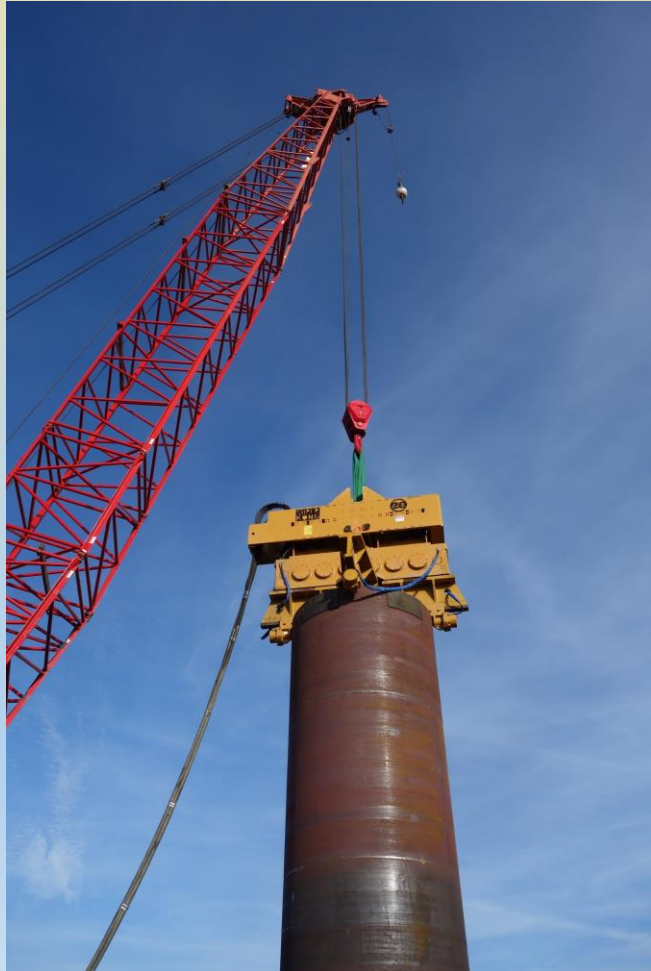

During all these years, APE has never damaged a crane boom due to excessive vibration. This is due to the APE Two-Stage Suppressor which is the BEST vibration dampening system in the foundation industry and is superior to any other suppressor system available to the contractor, including the Tunkers vibration dampener.

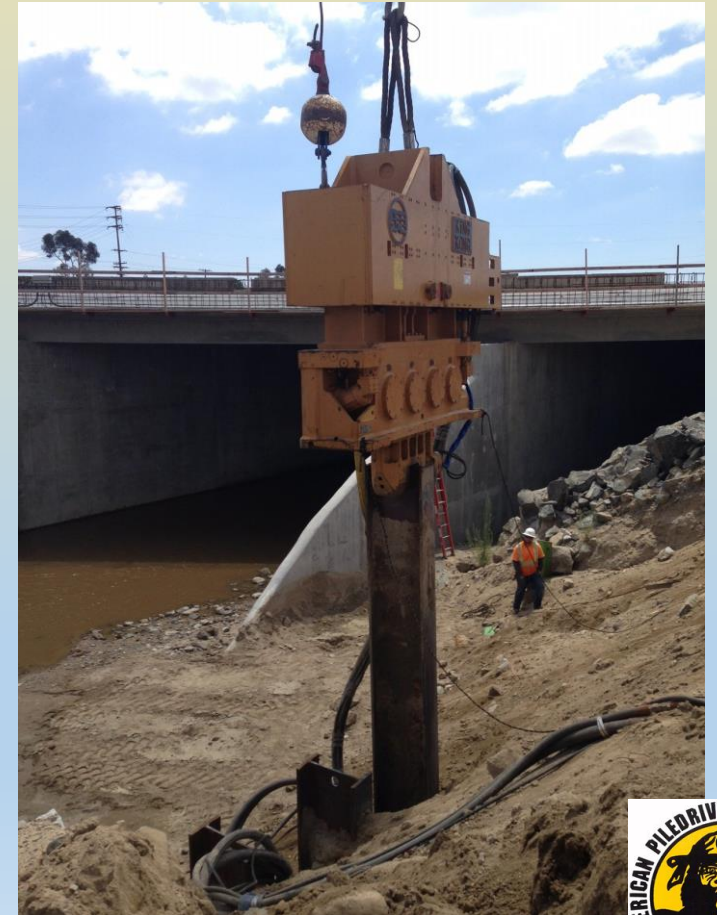

I would like to introduce you to the APE Two-Stage Suppressor Technology

Understanding Vibro Suppressors

Old Technology
Single Stage Suppressor

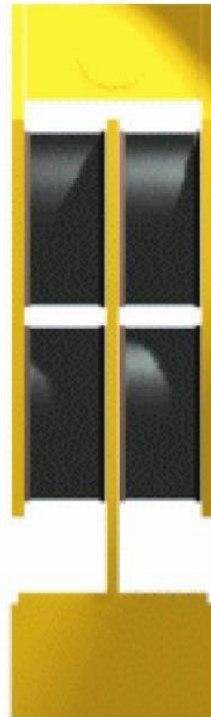

New Technology
APE Two-Stage
Suppressor System



APE Two-Stage Suppressor

Relaxed or Driving Position
All Elastomers are in neutral suspension



Small Elastomers
Stiffer but higher
capacity line pull

Large Elastomer
Much Softer with
lower capacity line pull

1st Stage Line Pull
Vibration Dampening



1st Stage

Large SOFT Elastomers
initially start with line
pull of crane with no
residual vibration to the
boom

Depending on size of
vibro this 1st Stage is
good for up to 90 Tons
of line pull



2nd Stage

Small elastomers pick
up the difference
between the maximum
line pull and where the
Large elastomers leave
off.

**Much
more
capacity
with no
vibration
to the
crane
line.**

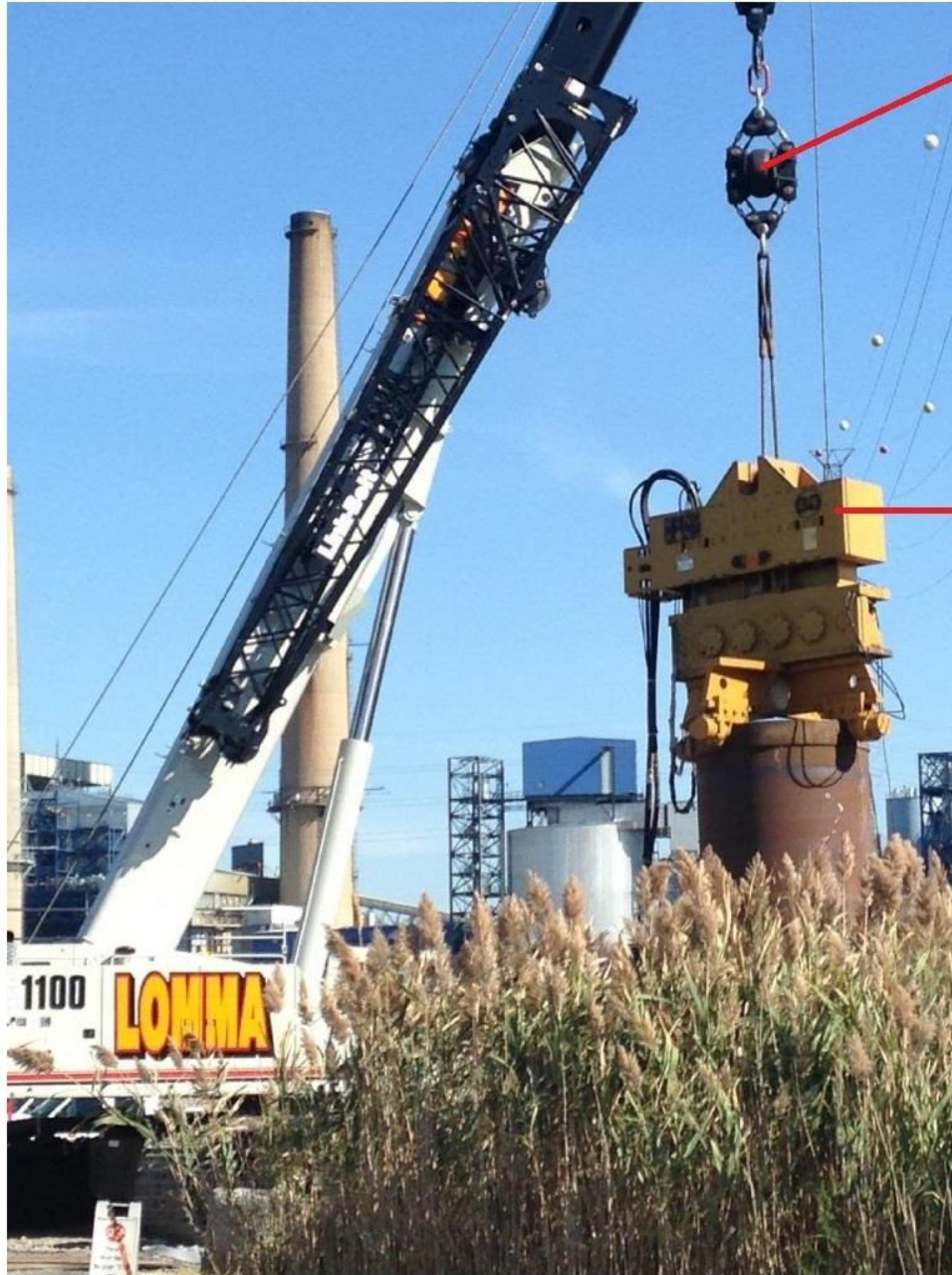

The Tunkers Vibration Dampener capacity is maximum 90 Tons of total line pull and when fully collapsed does nothing and may fail causing catastrophic damage to the crane and the equipment.

This Tunkers vibration suppressor limits the amount of line pull reducing the efficiency of the vibro

Built in APE Two-Stage Suppressor good for up to 90 Tons of line Pull in the first Large Elastomer "Soft" Stage with a total line pull of 250 Tons.

This Vibration Dampener is Dangerous to personnel as well as to the crane!

**This vibration Dampener is a safety hazard!
There are multiple reasons why you should not
use this when using an APE vibro.**

- 1) Reduces Line Pull Capacity
- 2) Multiple connections may cause failure
- 3) NO built in SAFETY device

**Shackle on both sides
may fail**

**Pins and cotter pins may
come loose and fail**

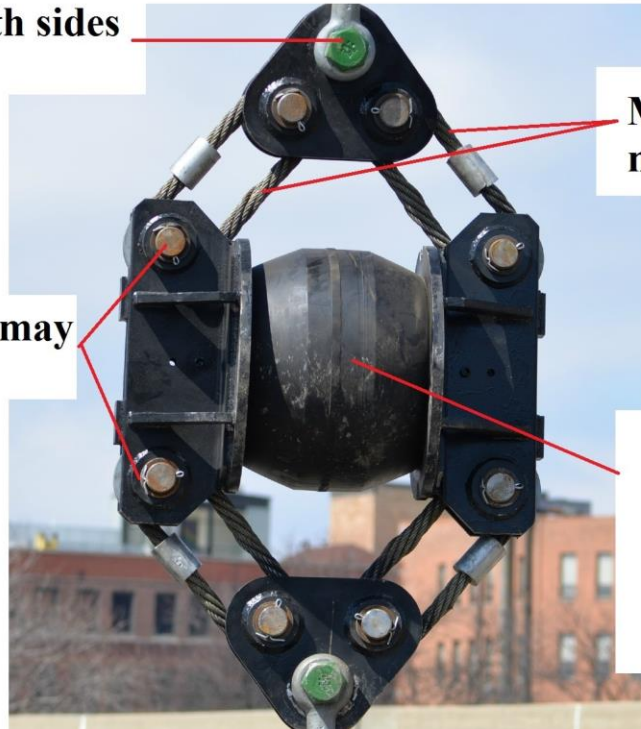

**Multiple cables
may break**

**If the cables
break there is NO
connection to the
crane and there is
NO built in safety
connection!**

**If the cables break or
come apart this vibration
ball will fall and can kill
someone or do damage to
the crane or other
equipment**

APE Two-Stage Suppressor

Large "Soft" Elastomers absorb the vibration in soft driving and soft extraction up to 90 Tons of line pull on some models.

The Small elastomers increase line pull capacity up to 250 Tons on some models.

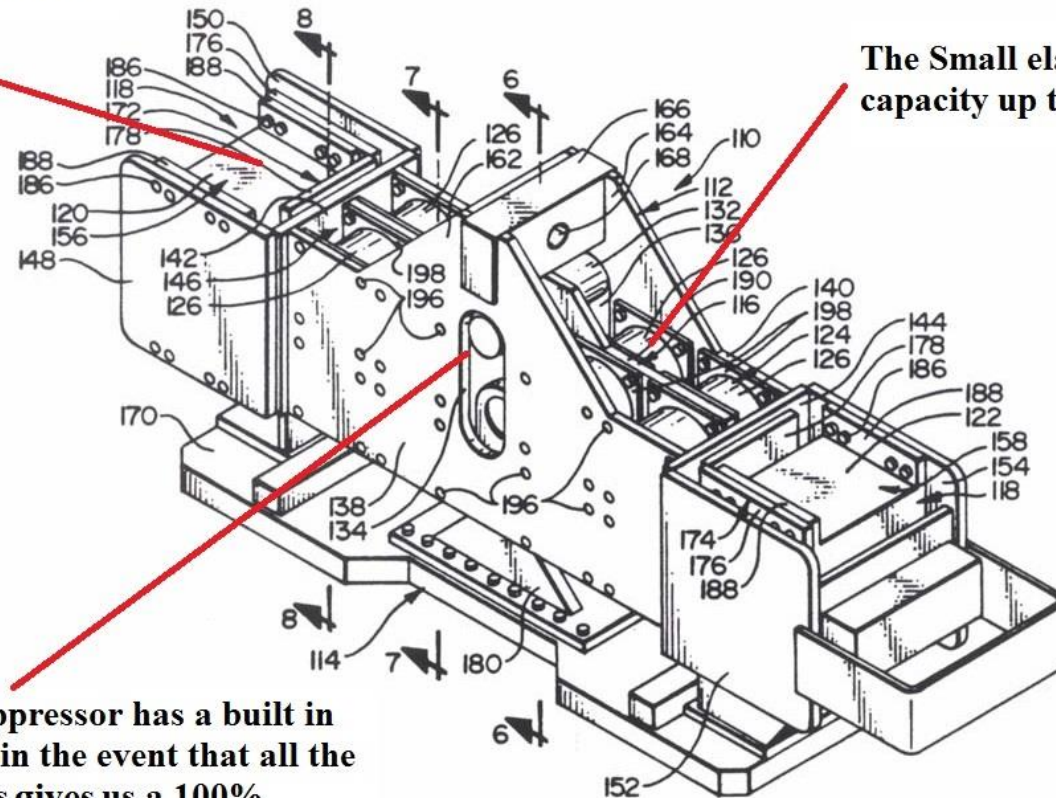

APE Two-Stage Suppressor has a built in safety "STOP" Pin in the event that all the elastomers fail. This gives us a 100% connection to the crane at all times which takes away the potential for damage to the crane and equipment in case of failure.

Bottom Line

The APE Two-Stage Suppressor System is time proven by the contractors that use them in the Foundation Industry World Wide! APE Vibratory Driver/ Extractor with the Two-Stage Suppressor does NOT need a vibration dampener as a solution to vibration.

**APE already has the solution to the vibration issue. The APE Two-Stage Suppressor!
It has been in use for over 25 years with out damaging a single crane due to excessive vibration!**

APE will let History speak for itself.

Talk to any of the contractors in the Foundation Industry that have used APE equipment and they will testify that the Two-Stage Suppressor stands the test of time!



